



**INFORMATION FOR FIRST AND SECOND RESPONDERS
EMERGENCY RESPONSE GUIDE**



**NISSAN QASHQAI
E-POWER HYBRID SUV
2025 -**



Contents

| | |
|-------------------------------------------------------------------|-----------|
| 0. Rescue sheet(s) | 5 |
| 1. Identification / recognition | 7 |
| 1-1 How to identify the Nissan Qashqai e-POWER Hybrid | 7 |
| 1-1.1 Vehicle Identification Number (VIN) | 8 |
| 1-1.2 Information on the dashboard | 9 |
| 1-1.3 High-Voltage-Related Component Locations and Descriptions | 10 |
| 1-1.4 Information under the hood | 11 |
| 2. Immobilisation / stabilisation / lifting | 12 |
| 2-1 Emergency Response Steps | 12 |
| 2-2 Preparation Items | 13 |
| 2-2.1 Personal Protective Equipment (PPE) Protective Wear Control | 14 |
| 2-2.2 Daily Inspection | 14 |
| 2-2.3 Insulated Tools | 14 |
| 2-3 Vehicle Immobilisation and Stabilisation | 14 |
| 3. Disable direct hazards / Safety regulations | 16 |
| 3-1 How to Handle a Damaged Vehicle at an Accident Scene | 16 |
| 3-2 High-voltage System Shut-Down Procedures | 17 |
| 3-3 Powering Down the High-voltage System | 18 |
| 3-3.1 MAIN DISABLING METHOD - Turn OFF the power | 18 |
| 3-3.2 ALTERNATIVE DISABLING METHOD 1 - Remove Service Plug | 19 |
| 3-3.3 ALTERNATIVE DISABLING METHOD 2 - Disconnect 12V Battery | 20 |
| 3-3.4 ACCESS to low voltage battery | 21 |
| 4. Access to the occupants | 22 |
| 4-1 Window Glass | 22 |
| 4-2 Opening Doors | 23 |
| 4-3 Steering wheel adjustment | 25 |
| 4-4 Seats adjustment | 25 |
| 4-5 Cutting the Vehicle Body | 27 |
| 4-6 High Strength Steel Locations | 28 |
| 5. Stored energy / Liquids / Gases / Solids | 29 |
| 5-1 General Fluid Spills and Gas Leaks | 29 |
| 5-1.1 Fluids and gases used in this vehicle | 29 |
| 5-1.2 Gas leaks | 29 |
| 5-2 Components Requiring Special Attention | 29 |
| 5-2.1 Low-voltage Battery | 29 |
| 5-2.2 High-voltage Battery | 30 |
| 5-2.3 Petrol fuel tank | 32 |

6. In case of fire 34

| | | |
|-------|------------------------------------|----|
| 6-1 | Vehicle fire | 34 |
| 6-1.1 | Fire Extinguishing | 34 |
| 6-1.2 | Use a thermal imaging camera | 36 |
| 6-1.3 | Gas strut - Risk of missile effect | 36 |

7. In case of submersion 37

| | | |
|-----|------------------|----|
| 7-1 | Water Submersion | 37 |
|-----|------------------|----|

8. Towing / transportation / storage 38

| | | |
|-------|-------------------------------------|----|
| 8-1 | Jump Starting Procedures | 38 |
| 8-2 | P (Park) Position Release Procedure | 39 |
| 8-3 | Towing Guidelines | 40 |
| 8-4 | Storing the Vehicle | 42 |
| 8-4.1 | Danger Sign Example | 43 |
| 8-5 | Preparation for Dismantling | 44 |

9. Important additional information 45

| | | |
|-----|------------------------------------------------|----|
| 9-1 | Recovery/Recycling of the High-voltage Battery | 45 |
| 9-2 | The Technology of e-Power | 46 |
| 9-3 | Passive Safety System Component Parts Location | 47 |

10. Explanation of pictograms used 49

| | | |
|------|--------------------------------|----|
| 10-1 | Explanation of pictograms used | 49 |
|------|--------------------------------|----|

Introduction

This document is intended to provide information to the first responders when carrying out rescue operations. It can also be useful for road assistance.

The document provides a comprehensive set of useful, relevant information, like:

- to recognize the right model,
- to learn about its main technical features,
- to identify the risks inherent to the onboard technology and therefore to adapt their resources and methods to act effectively in full safety.

In this Emergency Response Guide you will find the Nissan Qashqai e-POWER vehicle, sold in Europe.

Rescue Sheets have been made for each model of our vehicles. A Rescue Sheet (ISO 17840 Part 1) is “quick information” for the first responders on the accident scene.

0. Rescue sheet(s)



Nissan Qashqai e-Power
Type: J12, 5-door SUV
(2025 -)

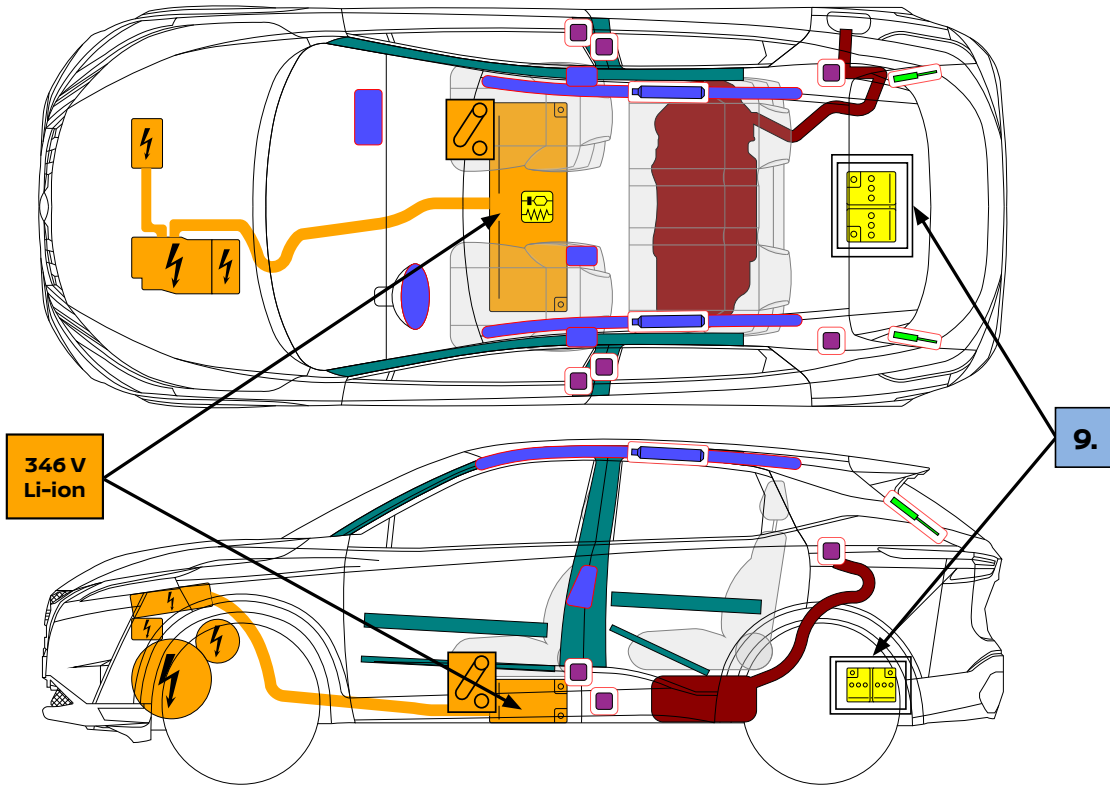

| | | | | | | | | | |
|--|----------------------------|--|------------------------------------|--|---------------------------------------------------|--|------------------------|--|----------------------------|
| | Airbag | | Stored gas inflator | | Seat belt pretensioner | | SRS control unit | | Battery low voltage |
| | Gas strut/preloaded spring | | High strength zone | | High voltage device that disconnects high voltage | | High voltage component | | Battery pack, high-voltage |
| | High voltage power cable | | Fuel tank content gasoline/ethanol | | | | | | |

NISSAN AUTOMOTIVE EUROPE SAS
 in co-operation with Bliksund The Netherlands B.V.
 07-2025

Document N°

RS25EN-OJ12E0EUR

Version N°

01

Page N°

1 / 4

The Rescue Sheets of all our vehicles are available on::

| Country | Rescue sheet page link |
|------------------|---------------------------------------------------------------------------------------------------------------------------------------|
| Austria | https://www.nissan.at/rescuers_page.html |
| Belgium (FR) | https://fr.nissan.be/rescuers_page.html |
| Belgium (NL) | https://nl.nissan.be/rescuers_page.html |
| Bulgaria | https://www.nissan.bg/first-responders.html |
| Croatia | https://www.nissan.hr/hitne-sluzbe.html |
| Czech Republic | https://www.nissan.cz/prvni_pomoc.html |
| Denmark | https://www.nissan.dk/rednings-kort.html |
| Estonia | https://www.nissan.ee/info-paastjatele.html |
| Finland | https://www.nissan.fi/pelastuskortti.html |
| France | https://www.nissan.fr/rescuers_page.html |
| French Guiana | https://www.nissan.fr/rescuers_page.html |
| Germany | https://www.nissan.de/rettungsdatenblaetter.html |
| Greece | https://www.nissan.gr/rescuers-page.html |
| Hungary | https://www.nissan.hu/elsegelynyujtok-informaciok.html |
| Iceland | https://www.nissan.is/first-responders.html |
| Ireland | https://www.nissan.ie/first-responders.html |
| Israel | https://www.nissan.co.il/rescuers-information.html |
| Italia | https://www.nissan.it/informazioni-soccorsi.html |
| La Reunion | https://www.nissan.re/rescuers_page.html |
| Latvia | https://www.nissan.lv/informacija-glabsanas-dienestiem.html |
| Lithuania | https://www.nissan.lt/gelbejimo-kortele.html |
| Luxembourg | https://www.nissan.lu/rescuers_page.html |
| Macedonia | https://nissan.mk/itni-sluzbi.html |
| Martinique | https://martinique.nissan.fr/services-de-secours.html |
| Montenegro | https://nissan.me/hitne-sluzbe.html |
| Netherlands | https://www.nissan.nl/rescuers_page.html |
| Norway | https://www.nissan.no/redningskort.html |
| Palestine | https://www.nissan.ps/TDIEU_MY21_Rescuers_page.html |
| Poland | https://www.nissan.pl/pierwsza-pomoc.html |
| Portugal | https://www.nissan.pt/servicosemergencia.html |
| Romania | https://www.nissan.ro/informatii-servicii-urgenta.html |
| Serbia | https://www.nissan.rs/hitne-sluzbe.html |
| Slovakia | https://www.nissan.sk/informacie-pre-zachranne-zlozky.html |
| Slovenia | https://www.nissan.si/resevalne-sluzbe.html |
| Spain | https://www.nissan.es/rescuers_page.html |
| Sweden | https://www.nissan.se/raddningskort.html |
| Switzerland (DE) | https://de.nissan.ch/rettungsdatenblaetter.html |
| Switzerland (FR) | https://fr.nissan.ch/rescuers_page.html |
| Switzerland (IT) | https://it.nissan.ch/rescuers_page.html |
| United Kingdom | https://www.nissan.co.uk/first-responders.html |

1. Identification / recognition



LACK OF ENGINE NOISE DOES NOT MEAN VEHICLE IS OFF. SILENT MOVEMENT OR INSTANT RESTART CAPABILITY EXISTS UNTIL VEHICLE IS SHUT DOWN. WEAR APPROPRIATE PPE.

1-1 How to identify the Nissan Qashqai e-POWER Hybrid

The vehicle can be identified by its brand badges, model badges and VIN number.

Brand name front



Nissan logo in the front grille

Brand name rear



Nissan logo on the rear lid

Model name



Model name on the centre of the rear lid, below the Nissan logo

Type



Lettering "e-Power" on the rear lid

1-1.1 Vehicle Identification Number (VIN)

The vehicle identification number can be located as follows.

Example VIN: JN1A/BF0BAXPM000000

- The High-voltage battery type is identified by the 4th alphanumeric character.
- The model type is identified by the 5th and 6th alphanumeric characters.



VIN at lower left end of front windshield



VIN at B-pillar driver side

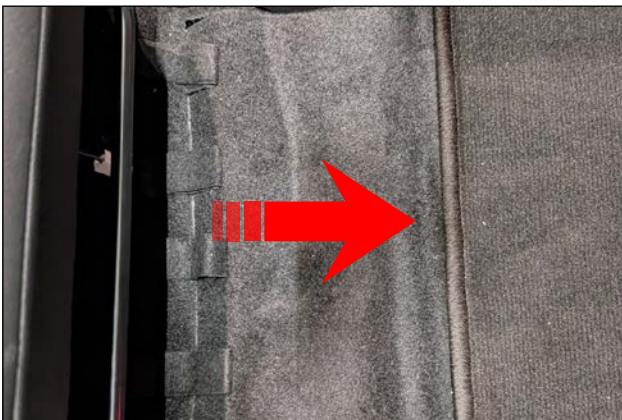

VIN stamped under the Front Right Seat on the frame underneath the cover







1-1.2 Information on the dashboard



1. Location of READY indicator

2. Gear Selector

The following warning and indicator lamps are located in the instrument cluster.

| Lamp Name | Icon | Description |
|----------------------------------------|----------------------------------------------------------------------------------------------------------------------------------------------------------------------------|------------------------------------------------------------------------------------------------------------------------------------------------------------------------------------------------------------------------------------------------------------------------------------------------------------------------------------------------------------------------------------------------------------------------------------------------------------------------------------------------------------------------------------------|
| READY Indicator (Green) |  | This lamp is on when the high-voltage system is powered up and the vehicle is ready to drive. |
| Master Warning Lamp (Orange or Red) |   | This lamp is on when another warning lamp or message is displayed in the instrument cluster. |
| Hybrid System Warning Lamp *1 (Orange) |  | This lamp is on or blinking when: <ul style="list-style-type: none"> • Malfunction has occurred in the hybrid control system and/or • High-voltage leak to vehicle chassis and/or • Emergency shut-off system has been activated. The shut-off system activates in the following conditions: <ul style="list-style-type: none"> – Front and side collisions in which the air bags are deployed. – Certain rear collisions – Certain high-voltage system malfunctions. |

*1: When this lamp is ON, the READY Indicator will turn OFF.

1-1.3 High-Voltage-Related Component Locations and Descriptions

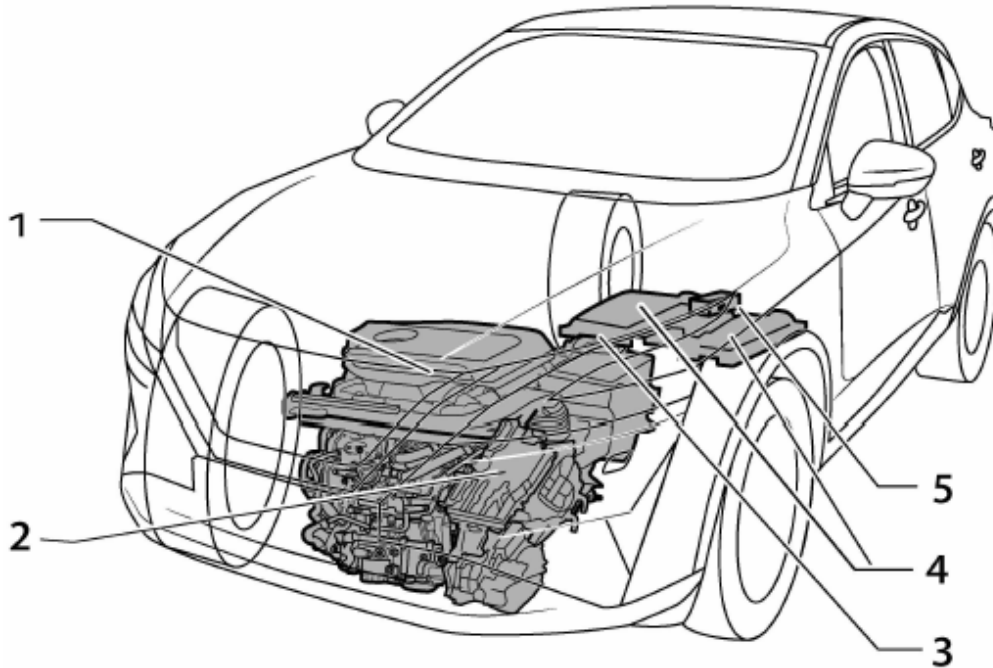
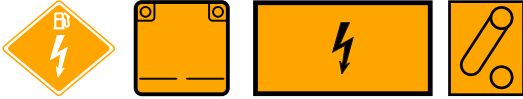

1. High voltage harnesses (orange)

These harnesses are high voltage and orange-colored. Be sure not to touch the harnesses or remove the connector on the base of the cable.

2. Inverter, power generator and electric motor for driving

a. Inverter

This device controls various functions related to the e-POWER system. Be careful because It can be hot after driving.

b. Power generator

This motor is for generating electric power. Be careful because It can be hot after driving.

c. Electric motor for driving

This motor is for running the vehicle. Be careful because It can be hot after driving.

3. Service plug

This plug is used to cut-off the high voltage when performing maintenance. Never touch this plug without wearing the appropriate Personal Protective Equipment (PPE).

1

2

3

4

5

6

7

8

9

10

4. Lithium ion (Li-ion) battery

This battery is charged from the electric power generated by the power generator and/or the regenerative power from the electric motor (driving). The Li-Ion battery also supplies the electric power to the electric motor (driving) while driving.

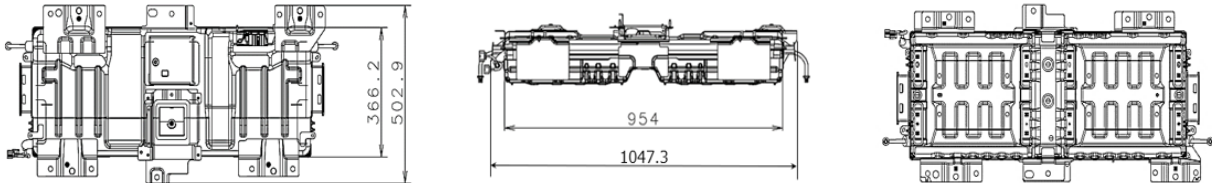

5. DC/DC converter

This converter takes Li-ion battery energy to supply 12-volt grid and to charge 12-volt battery.

1-1.4 Information under the hood

High Voltage Battery specifications

| | |
|----------------------|----------------------|
| Type | Li-ion Battery |
| Configuration | 4 Modules (96 cells) |
| Rated Voltage | 346 Volt |
| Total weight | 54 kg (119 lb) |

Warning Label

This warning label is applied to the on board charger located under hood.

**WARNING / AVERTISSEMENT
ACHTUNG / ADVERTENCIA / AVISO**

HIGH VOLTAGE INSIDE
•DO NOT remove these covers and /or connectors.

HOCHSPANNUNGSFÜHRENDE TEILE IM INNEREN
•Diese Abdeckungen bzw. Stecker nicht entfernen.

HAUTE TENSION À L'INTÉRIEUR
•NE PAS enlever ces couvercles et connecteurs.

Alta Voltagem no interior
•Nunca remova esta cobertura e/ou conector.

Alto voltaje en el interior
•Nunca remueva esta tapa y/o conector.

A

2. Immobilisation / stabilisation / lifting

2-1 Emergency Response Steps







- Failure to properly shut down the high-voltage electrical system before the Emergency Response Procedures are performed will result in serious injury or death from electrical shock. To prevent serious injury or death, **NEVER** touch high-voltage harnesses or components without always wearing appropriate Personal Protective Equipment (PPE).
- If it is necessary to touch any of the high-voltage harnesses or components you must always wear appropriate PPE to avoid electrical shock. Shut down the high-voltage system by following the steps outlined in 3-3 Powering Down the High-voltage System. Wait at least ten (10) minutes for complete discharge of the high-voltage capacitor after the high-voltage system has been shut down.



- **NEVER** assume the vehicle is shut OFF simply because it is quiet.
- Some of the under hood parts get hot and may cause serious burns. Use caution when working on or around these parts.

2-2 Preparation Items

| Preparation Items | Specification | Purpose |
|----------------------------------------------------------------------------------------------------|------------------------------------------------------------------------------------------------------------------------------------------------|--------------------------------------------------------------------------------------------------------------------------|
| Personal Protective Equipment (PPE): | | For protection from high-voltage electrical shock. |
| Insulated gloves  | Up to 1,000V 1,000V | |
| Insulated shoes  | - | |
| Safety shield  | - | |
| Leather gloves  | Must be able to fasten tight around the wrist (worn over insulated gloves). | To protect insulated gloves. |
| Wrenches  | Size: 10mm | To remove the service plug access cover bolts. To remove the 12-volt battery terminal bolt. |
| Solvent resistant protection gloves. Solvent resistant protection shoes. | - - | To utilize in the event of a high-voltage battery electrolytic solution leak. |
| Absorbent pad. | The same pad used for internal combustion engine fluids can be used. | To absorb any high-voltage battery electrolytic solution leakage. |
| Standard fire fighting equipment. | Standard fire fighting equipment. Depending on type of fire (vehicle or battery) use standard fire fighting equipment (water or extinguisher). | To extinguish a fire. |
| Insulated tape. | Insulating. | To cover any damaged harnesses to protect from and prevent electrical shock. Tape should cover all bare or damaged wire. |

2-2.1 Personal Protective Equipment (PPE) Protective Wear Control

Perform an inspection of the Personal Protective Equipment (PPE) items before beginning work. Do not use any damaged PPE items.

2-2.2 Daily Inspection

This inspection is performed before and after use. The responder who will be using the items should perform the inspection and check for deterioration and damage.

- Insulated rubber gloves should be inspected for scratches, holes and tears. (Visual check and air leakage test)
- Insulated safety boots should be inspected for holes, damage, nails, metal pieces, wear or other problems on the soles. (Visual check)
- Insulated rubber sheet should be inspected for tears. (Visual check)

2-2.3 Insulated Tools

When performing work at locations where high-voltage is applied (such as terminals), use insulated tools meeting 1,000V/300A specifications.

2-3 Vehicle Immobilisation and Stabilisation

Before carrying out rescue operations, completely immobilise the vehicle by following these procedures to ensure safe emergency response operations:

1. Block wheels

If possible, immobilise the vehicle by turning the 12V system OFF and stabilize it with a wheel chock(s).

- **First Responders:**
Stabilize the vehicle with cribbing, by removing air from the tires, or utilize the Lift Airbag Equipment for rescue.
- **Dismantlers/Roadside Assistance Workers:**
Stabilize the vehicle with wooden blocks or by removing air from the tires.



1

2

3

4

5

6

7

8

9

10

2. Apply parking brake

3. Push the P (park) button to select the P (park) position



- Do not stabilize the vehicle with cribbing under the high-voltage battery.
- To avoid electrical shock, do not put the Lift Airbag Equipment for rescue and wheel chock(s) under the high-voltage components and harnesses. Refer to the rescue sheet or the image below for location of high-voltage components and harnesses.



Lifting points:

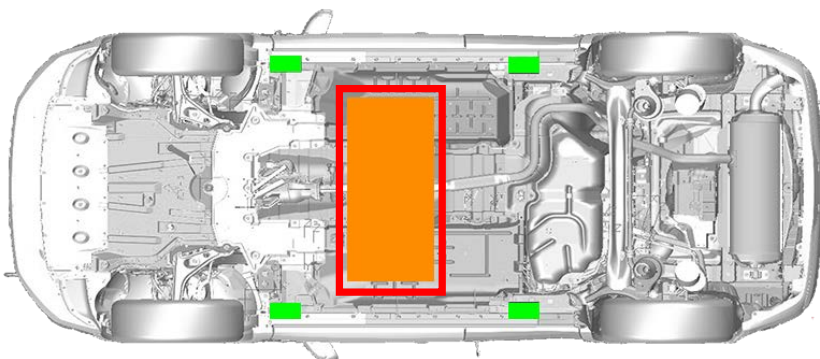

Appropriate lifting points



High voltage battery



Do not lift zone

3. Disable direct hazards / Safety regulations

3-1 How to Handle a Damaged Vehicle at an Accident Scene

NOTE:

If any air bags have deployed in the following 3 situations, the high-voltage (HV) system has been designed to automatically shut off at the time of deployment.

The high-voltage system incorporates capacitors which are energized whenever the high-voltage system is on. If the high-voltage system is shut down (either through one of the built-in automatic mechanisms or manually through one of the procedures explained in this ERG), the capacitors will begin to gradually discharge. After 5 minutes, the voltage level will have dropped below 60V, and complete discharge requires approximately 10 minutes after high-voltage system shut down. It is within this period of time that responders must be most cautious.

When arriving to an incident involving a vehicle with a high-voltage system, the vehicle should be approached with caution and inspected for the level of damage. In addition to overall vehicle condition (location and severity of body damage, air bag deployment, etc.), the high-voltage system should be assessed specifically. Appropriate Personal Protective Equipment (PPE) must always be worn when approaching a vehicle of unknown condition, as described in this ERG.

If there is any evidence that the High-Voltage (HV) system has been compromised (such as arcing / sparking, orange wiring harnesses cut or damaged, HV component casings damaged etc.), then the HV system is damaged. If there is no evidence the HV system has been compromised, it can be implied the HV system is intact but not assured.

Situation 1) High-voltage system intact, occupants can be accessed without extrication tools

The HV system can be shut down by following the procedures in this guide, while wearing appropriate PPE. After HV system shut down, occupant assistance can begin immediately, and no wait period is necessary.

Situation 2) High-voltage system intact, occupants cannot be accessed without extrication tools

The HV system can be shut down by following the procedure in this guide, while wearing appropriate PPE. After HV system shut down, absolute care must be taken not to cut through or damage any HV system wiring, battery or components within ten (10) minutes of HV system shut down, but occupant assistance operations using extrication equipment can begin immediately. The locations of the HV components are illustrated in this guide

Situation 3) High-voltage (HV) system damaged

The vehicle must be approached with extreme caution prior to initiating any system shut down procedures or rendering assistance to occupants. Appropriate PPE must always be worn as described in this guide, and the ten (10) minute wait time must be observed after HV system shut down in order to ensure the system is de energized.

In rare situations where vehicle damage is very severe, HV system shut down procedures as described in this guide may not work. In these instances extreme caution and appropriate risk management must be followed to prevent shock or electrocution to the responder or occupant..

3-2 High-voltage System Shut-Down Procedures

Any of the following procedures can shut down and isolate the high-voltage system. The first response operation should only begin after shutting down the high-voltage system. If the vehicle is heavily damaged, for example the high-voltage battery is deformed, broken or cracked, appropriate Personal Protective Equipment (PPE) must always be used and the high-voltage battery and high-voltage components must not be touched.



- Failure to properly shut down the high-voltage system before the Emergency Response Procedures are performed will result in serious injury or death from electrical shock. To prevent serious injury or death, NEVER touch high-voltage harnesses or components without always wearing appropriate Personal Protective Equipment (PPE). PPE must always be worn when touching or working on high-voltage components.
- When contact with high-voltage components or high-voltage harnesses is unavoidable, or when there is risk of such contact, you must always wear appropriate PPE. PPE must always be worn when touching or working on high-voltage components.



- The vehicle contains parts that contain powerful magnets. If a person who is wearing a pacemaker or other medical device is close to these parts, the medical device may be affected by the magnets. Such persons must not perform work on the vehicle.
- Be sure to verify that the READY indicator is off and the high-voltage system is stopped.
- After the high-voltage system is shut down, please wait at least ten (10) minutes for complete discharge of the high-voltage capacitor. While waiting, do not operate any vehicle functions.

NOTE:

The high-voltage full discharge takes ten (10) minutes, but after five (5) minutes the voltage has dropped below 60V.

- After shutting down the high-voltage system and removing the 12-volt battery negative (-) terminal, wait at least three (3) minutes to discharge the air bag capacitor. Even though the 12-volt battery negative (-) is disconnected, the Supplemental Restraint System (SRS) air bag maintains voltage at least three (3) minutes. During this time, there is a possibility of sudden SRS air bag inflation due to harness short circuit or damage and it may cause serious injuries.
- Always shut down the high-voltage system before disconnecting the 12-volt battery. Not doing so may result in serious injury or death from electrical shock.
- The 12V system will remain active even after the 12-volt battery negative (-) terminal is removed while the high-voltage system is active. The high-voltage system is active during any of the following conditions:

3-3 Powering Down the High-voltage System

The high-voltage system can be shut down with any of the following procedures:

- **MAIN DISABLING METHOD - Turn OFF the power**
- **ALTERNATIVE DISABLING METHOD 1 - Remove Service Plug**
- **ALTERNATIVE DISABLING METHOD 2 - Disconnect 12V Battery**

3-3.1 MAIN DISABLING METHOD - Turn OFF the power

If the "Ready" indicator in the instrument cluster is illuminated press the Start/Stop button once. Then the high voltage system is disabled.



Then, remove the Nissan Intelligent Key® and keep it at least 16 ft. (5 m) away from the vehicle to prevent accidentally turning ON the HV system.

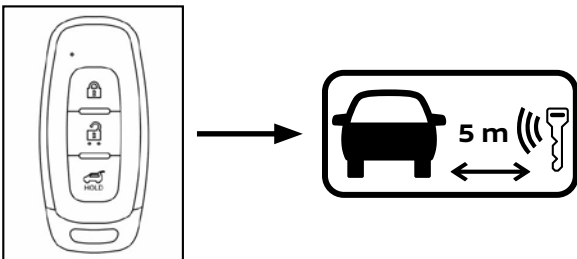

- Since the accessory power is turned on by the auto ACC function, no vehicle operations such as operating the door locks or opening/closing the doors should be performed during standby.
- If the vehicle is operated, wait at least 5 additional minutes from that point.

1

2

3

4

5

6

7

8

9

10

3-3.2 ALTERNATIVE DISABLING METHOD 1 - Remove Service Plug

Access to the Service Plug

The Service Plug is located under the front right seat, and can be accessed by performing these steps:



1. Slide the front right seat backwards
2. Open the zipper on the lower front-facing surface of the rear center seat cushion
3. Remove the service plug terminal cover mounting bolt and nuts, and remove the service plug terminal cover



Removing the Service Plug

Remove the service plug using the following steps: (1) push up lever until it stops, (2) press pawl to unlock, (3) push up lever, (4) pull out service plug.

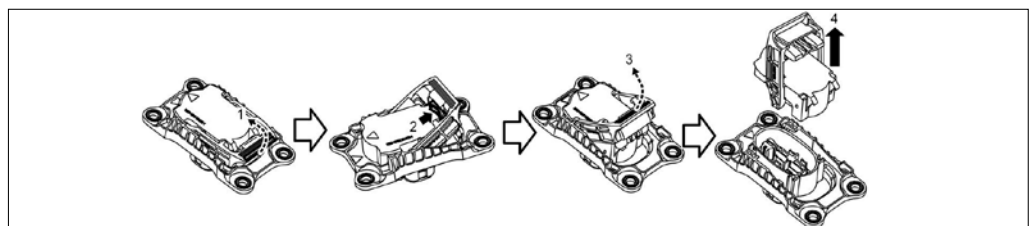

Wait at least (10) minutes for complete discharge of the high-voltage capacitor after the service plug has been removed.

1

2

3

4

5

6

7

8

9

10



- Do not remove the service plug without always wearing appropriate Personal Protective Equipment (PPE) to help protect the responder from serious injury or death by electrical shock.
- Immediately cover the service plug socket with insulated tape. The high-voltage battery retains high-voltage power even when the service plug is removed. To avoid electric shock, NEVER touch the terminals inside the socket.



To avoid personal injury do not access to service plug if the following conditions exist.

- Smoke is coming from battery
- The odor of smoke is present

Before removing the service plug, check the following:

- Confirm with infrared thermometer that battery surface and inspection hole cover temperature is lower than the surrounded ambient temperature. If an infrared thermometer is not available, you must observe the battery for more than 24 hours to confirm battery is stable before removal.
- Confirm that there is no damage to the service plug.

3-3.3 ALTERNATIVE DISABLING METHOD 2 – Disconnect 12V Battery

1. Open the trunk (refer to 4-2 Opening Doors)
2. Remove the cover
3. Disconnect the 12V battery negative (-) cable. Insulate the negative (-) battery cable terminal with insulated tape.

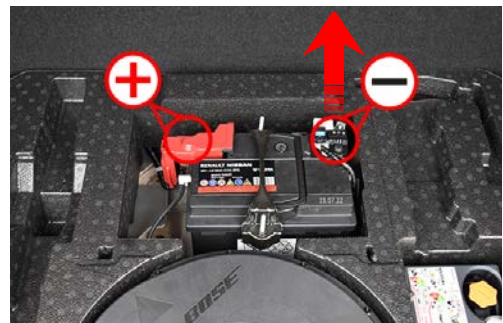
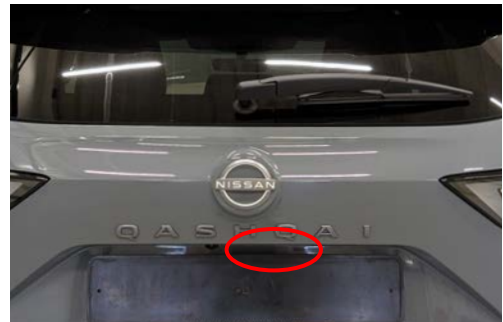
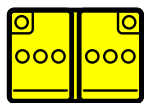

1

2

3

4

5

6

7

8

9

10

Perform the emergency response, roadside assistance action or dismantling operation.



Safety instructions:

Never touch, cut, or open any orange high voltage power cable or high voltage component!

3-3.4 ACCESS to low voltage battery

Please refer to 3-3.3 ALTERNATIVE DISABLING METHOD 2 - Disconnect 12 Volt battery, for information on how to access the low voltage battery.

4. Access to the occupants

4-1 Window Glass

Laminated glass and tempered glass are widely used for vehicle windows.

Laminated glass

Laminated glass is used for the windshield and roof glass. It is composed of two layers of glass with a film in-between. When objects collide with the glass, they are less likely to penetrate it, and any glass fragments tend to stay attached to the film. While sawing in laminated glass, glass dust and little glass fragments are given off, which could be health-threatening and/or dangerous for the occupant(s) and first responders.



Tempered glass

Tempered glass is used for door glass and back window glass. In the event of breakage, tempered glass shatters into very small pieces. It offers greater resistance to breaking, even when impacted by an object.



1

2

3

4

5

6

7

8

9

10

4-2 Opening Doors

Opening the doors from the outside

When the doors are unlocked, they can be opened by operating the handle on the door.



Opening the doors from the inside

When the doors are unlocked, they can be opened by operating the handle on the door.



1

2

3

4

5

6

7

8

9

10

Opening the tailgate from the outside



Opening the tailgate from the inside

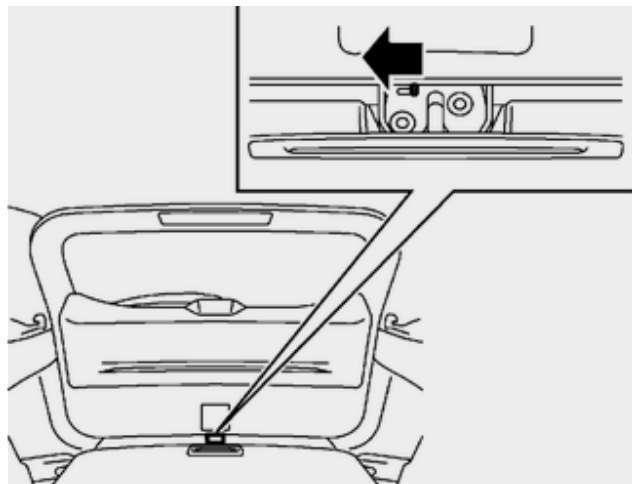

4-3 Steering wheel adjustment

Manual steering wheel

Pull the lock lever(1) down and adjust the steering wheel up or down, forward or rearward to the desired position. Push the lock lever up securely to lock the steering wheel in place.

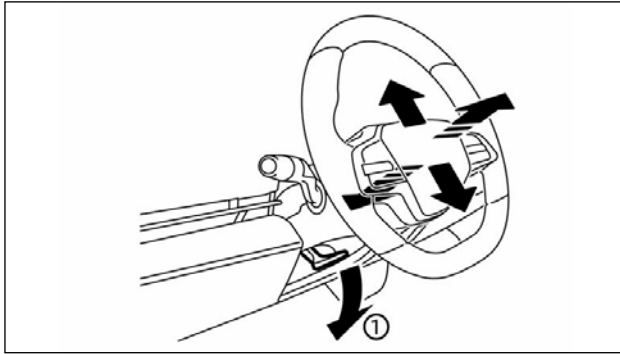

4-4 Seats adjustment

Manual seat

Front seat can be adjusted forward/backward manually by pulling up and holding lever (1), tilted forward/backward manually by pulling up and holding lever (2) and pull up or push down the adjusting lever (3) repeatedly to adjust the seat height until the preferred position is achieved.

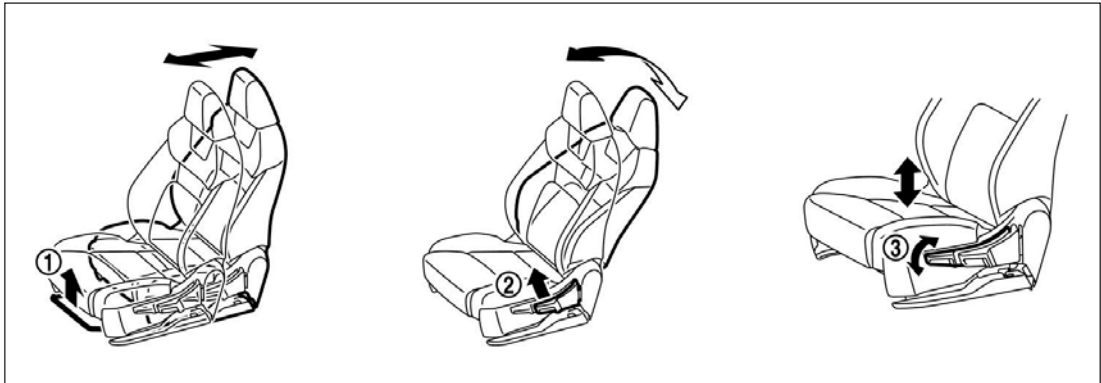

1

2

3

4

5

6

7

8

9

10

Power seat

Seat Position: Move the seat position to forward or backward by the adjusting switch (1).

Seat-Back: Move the seat-back to forward or backward by the adjusting switch (2).

Seat Lifter: Move the seat height to desired position by the adjusting switch (3).

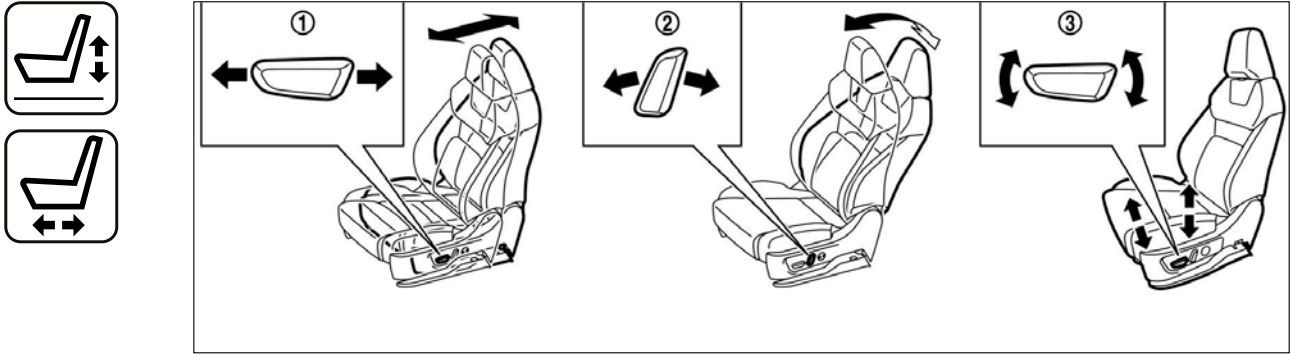

Removing head restraint

The front seat head restraint can be removed (if necessary) by pressing the lock knob and pulling it up.

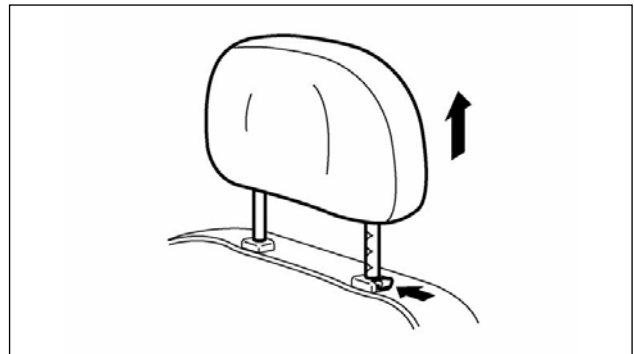

Unfasten the seat belt

The seat belt can be unfastened by pressing the release button. If seat belt cannot be unfastened, cut it with a belt cutter.

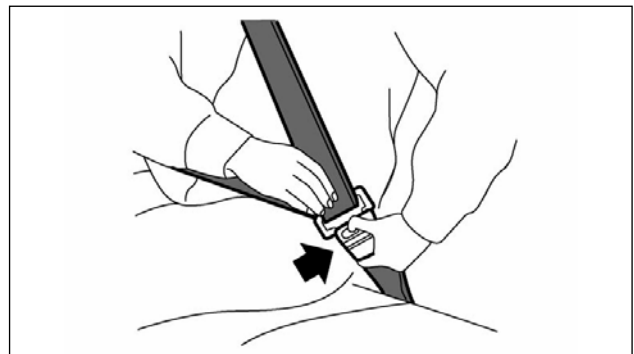

Powered functions like the windows, power seat position adjustment and electric steering wheel adjustment will be disabled when the 12V battery is disconnected.

1

2

3

4

5

6

7

8

9

10

4-5 Cutting the Vehicle Body



- Do not cut into high-voltage related areas to avoid severe personal injury or death.
- Do not cut into the high-voltage battery to avoid severe personal injury or death.
- When removing parts, NEVER touch the high-voltage parts or the insides of the exposed orange-colored high-voltage cables to avoid severe personal injury or death. Personal Protective Equipment (PPE) must always be worn when touching or working on high-voltage components.



Do not cut air bag parts to avoid unintended deployment of the air bags and the risk of severe personal injury or death.

If at least ten (10) minutes have passed since the rescuer shut down the high-voltage system (refer to 3-3 Powering Down the High-voltage System), then the rescuer can cut the vehicle except for the high-voltage battery.

If the rescuer cannot wait the full ten (10) minutes or shut down the high-voltage system, absolute care must be taken to avoid cutting HV parts and appropriate Personal Protective Equipment (PPE) must always be worn. DO NOT cut the high-voltage battery due to possible electrocution risk and electrolyte solution leakage.

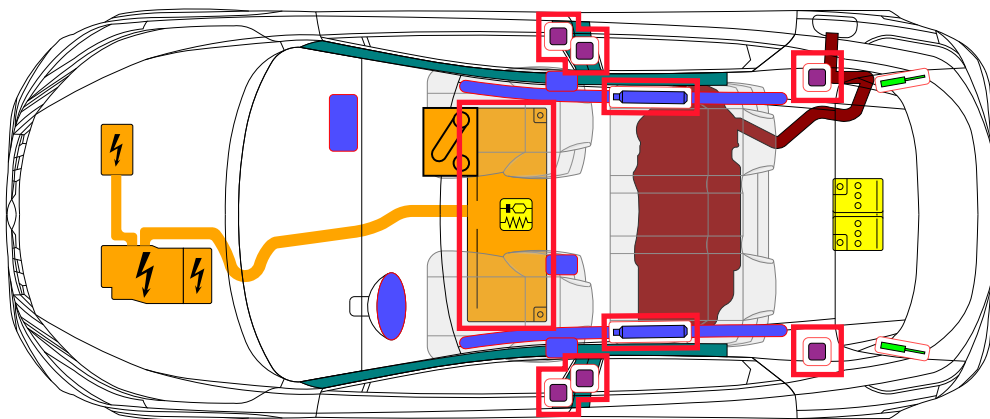

No Cut Zone

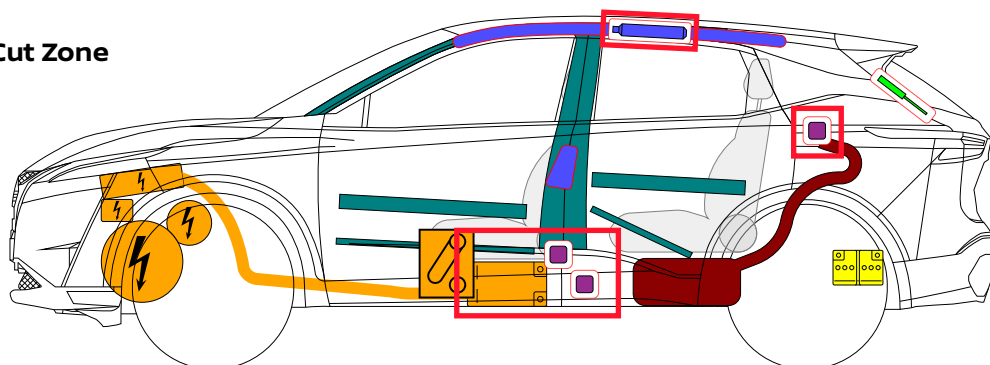

1

2

3

4

5

6

7

8

9

10

4-6 High Strength Steel Locations

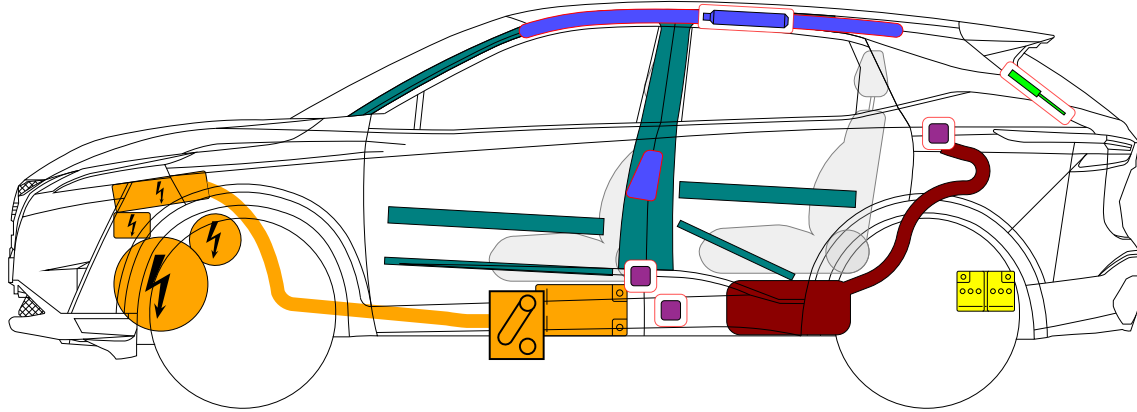

High Strength Zone

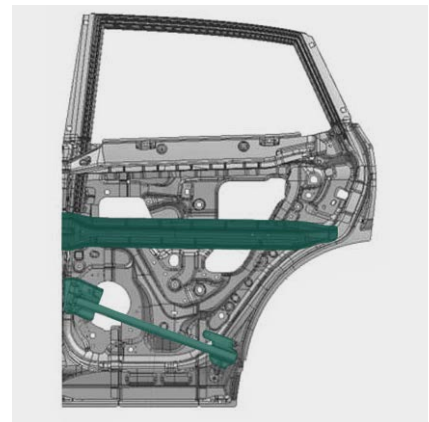
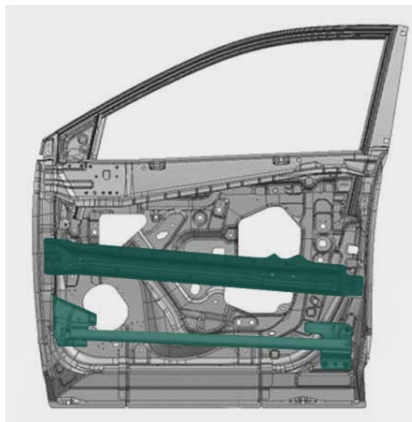















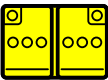

Because the strength of side impact protection beam and ultra high tensile strength sheet steel is higher than sheet steel and high tensile strength sheet steel, it is difficult to cut through side impact protection beam and ultra high tensile strength sheet steel with conventional cutters. Avoid side impact protection beam and parts made from ultra high tensile strength sheet steel when cutting a vehicle.

5. Stored energy / Liquids / Gases / Solids

5-1 General Fluid Spills and Gas Leaks

5-1.1 Fluids and gases used in this vehicle

| Type | Capacity | Dangers |
|------------------------------------------------------------------------------------------|------------------|------------------------------------------------------------------------------------------------------------------------------------------------------------------------------------------------------------------------------------------------------------------------------------------------------------------------------------------------------------------------------------------------------------------------------------------------------------------------------------------------------------------|
|  Li-ion | 346 V |       |
|  | 12 V |   |
|  | R-1234yf 550g |     |
|  | 55L |   |

5-1.2 Gas leaks

There are various types of gas used in vehicles. For example, there is nitrogen (N₂) gas used in gas filled dampers and refrigerant gas for air conditioners

Refrigerant Gas

- The refrigerant gas used in air conditioner is R-1234yf.
- The gas is containing carbon and fluorine.
- The gas is colorless, odorless, and harmless.

5-2 Components Requiring Special Attention

The construction and functions of components requiring special attention during emergency response are described in this section.

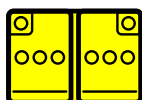

5-2.1 Low-voltage Battery

- The 12 V battery supplies power to the ECUs that control various systems and auxiliary components such as the power door lock, power window, power seat, etc.
- For the sake of ensuring safe emergency response operations, it is necessary to completely shut off the vehicle. Before performing any work, disconnect the negative battery terminal from the 12 V battery and remember to shut off the power to the electrical system. This will prevent electrical fires and keep the vehicle from starting.
- It is important to note that the 12 V battery electrolyte contains dilute sulfuric acid.
- Depending on the model, the 12 V battery can be found in various locations in the luggage compartment.

Alternative 12V Battery layouts

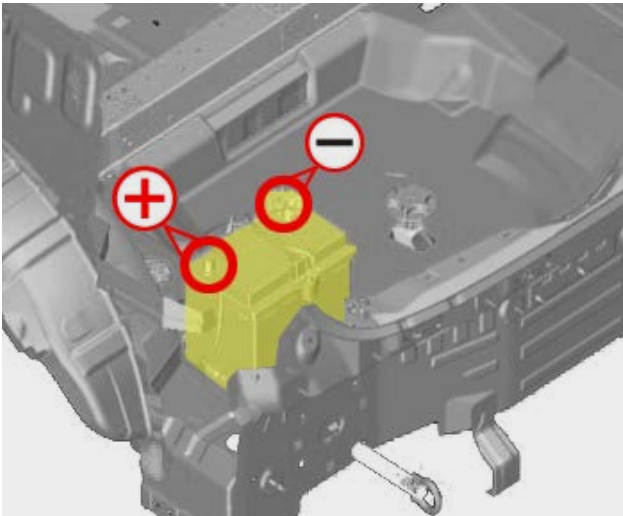

Alternative 12V Battery layout 1

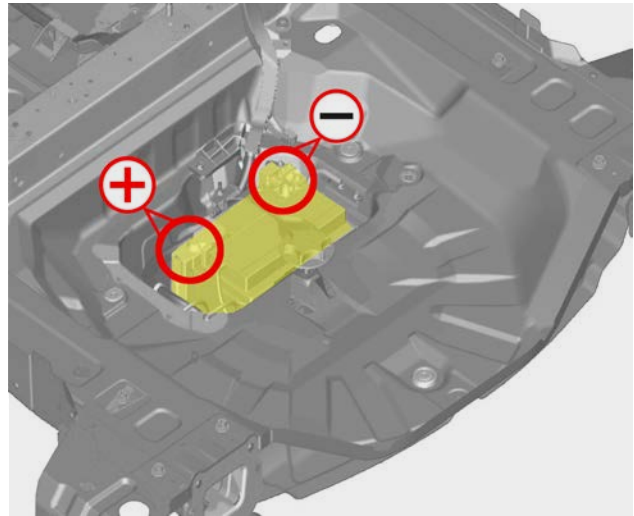

Alternative 12V Battery layout 2



5-2.2 High-voltage Battery

First Responders:

If electrolyte solution leakage, or damage such as any problem with the high-voltage battery casing are observed, first responders should attempt to neutralize the battery by applying a large volume of water to the battery pack while wearing appropriate Personal Protective Equipment (PPE). The neutralization process helps stabilize the thermal condition of the battery pack but does not discharge the battery.

Dismantlers/Roadside Assistance Workers:

In cases of battery case breach or electrolyte leakage, contact the fire department immediately. If you must walk away from the vehicle, notify an appropriate responder of the fact that the vehicle contains a high-voltage system and warn all others.

High-voltage Battery Electrolyte Solution Characteristics:

- Clear in color
- Sweet odor
- Similar viscosity to water
- Since the high-voltage battery is made up of many small sealed battery modules, electrolyte solution leakage should be minimal.

Please refer to 1-1.3 High-Voltage-Related Component Locations and Descriptions, for battery specifications.

1

2

3

4

5

6

7

8

9

10



When conventional coolant leaks (check reservoir) from the high voltage (HV) battery cooling system, HV-battery can become unstable with risk of thermal runaway. An increasing HV-battery temperature might be an indicator of thermal runaway.



The battery assembly cover should never be breached or removed under any circumstances, including fire. Doing so might result in severe electrical burns, shocks, or electrocution.



When dealing with wastewater from extinguishing lithium-ion battery fires, fire services must treat it as hazardous waste due to its potential chemical contamination.



The high-voltage battery contains electrolyte solution. To avoid exposure to electrolyte solution and serious personal injury, always wear appropriate solvent resistant Personal Protective Equipment (PPE) and read the following precautions:

- Electrolyte solution is a skin and eye irritant – If contact with skin or eyes, rinse with plenty of water and see a doctor immediately.
- If electrolyte leak occurs, wear appropriate solvent resistant PPE. Absorb the electrolyte with a piece of dry cloth or equivalent absorbent material, and keep it in an airtight container for proper disposal. Be sure to adequately ventilate the area.
- Electrolyte solution is highly flammable.
- Electrolyte liquid or fumes that have come into contact with water vapors in the air will create an oxidized substance. This substance may irritate skin and eyes. In these cases, rinse with plenty of water and see a doctor immediately.
- Electrolyte fumes (when inhaled) can cause respiratory irritation and acute intoxication. Move to fresh air and wash mouth with water. See a doctor immediately.

1

2

3

4

5

6

7

8

9

10



5-2.3 Petrol fuel tank

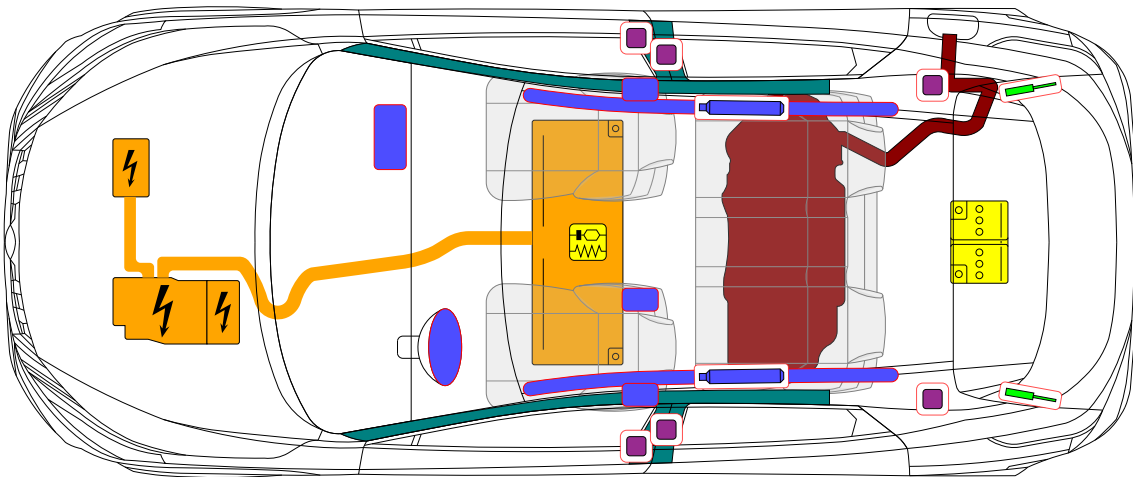

Fuel Tank Location

The fuel tank is positioned below the rear seat underneath the compartment floor.

Characteristics of Class 2 Fuel

Class 2 fuel consists of a complex blend of various hydrocarbons and may include small amounts of additives. These fuels are highly flammable, toxic, and hazardous to health.

Precautions in the Event of a Fuel Leak

- Keep away from all sources of ignition
- Turn off the engine immediately
- Use an inert absorbent material to soak up the fuel, and transfer it into an appropriate disposal container
- Only use spark-resistant tools and explosion-proof equipment

General Safety Warning

Danger of explosion from ignition sources, risk of poisoning through inhalation or ingestion, and potential injury from skin or eye contact with fuel.

- Open flames, sparks, and smoking are strictly prohibited
- Store and handle fuel only in suitable, clearly labeled containers
- Always wear appropriate protective clothing when working with fuel

1

2

3

4

5

6

7

8

9

10



First responders must be well-prepared to handle emergencies involving fuel tanks, as these situations can pose risks such as fire, explosions, and hazardous material spills.

Safety Considerations:

- **Approach with Caution, always treat fuel tanks as potentially hazardous. Avoid open flames, sparks, or tools that could generate heat or friction.**
- **Understand the fuel involved (e.g., gasoline, diesel, propane, aviation fuel).**
- **Use Personal Protective Equipment (PPE); Use fire-resistant clothing, gloves, and footwear. Wear self-contained breathing apparatus (SCBA) when vapors or fire are present.**

6. In case of fire

6-1 Vehicle fire

When dealing with Nissan vehicle fires in emergency situations, it's important to follow specific procedures and take note of crucial points. For information on the pictograms used, please refer to chapter 10 for an explanation.



6-1.1 Fire Extinguishing

Water is a proven effective extinguishing agent. Additionally, it is essential to use a fire extinguisher suitable for flammable liquid fires (such as gasoline, grease, oil, etc.), electrical fires (involving electrical wiring, electric devices, etc.), and general fires (involving solid objects, etc.).



LARGE AMOUNTS OF PURE WATER



- Always utilize full Personal Protective Equipment (PPE) and self-contained breathing apparatus during fire fighting operations. Smoke from an Nissan e-POWER vehicle fire is similar to smoke from a conventional vehicle fire.
- In the case of extinguishing a fire with water, large amounts of water from a fire hydrant (if possible) must be used. DO NOT extinguish fire with a small amount of water.



In the event of a small fire, a Type ABC fire extinguisher may be used for an electrical fire caused by wiring harnesses, electrical components, etc. or oil fire.

Please refer to the National Fire Protection Association's web site and the latest version of the "NFPA® Alternative Fuel Vehicle Emergency Field Guide" for training and information on fighting electric vehicle fires.

Fire attack should follow standard fire fighting practices.

If you must walk away from the vehicle, notify an appropriate responder or a rescue person of the fact that the vehicle is an hybrid car and contains a high-voltage system and warn all others.

During overhaul operations (late stage fire suppression process to examine for remaining sources of heat), make sure the battery is fully cooled to avoid fire re-ignition. The battery could reignite if it is placed near fire. To avoid possible electrical shock and serious personal injury, do not breach the high-voltage battery case.



In a fire situation involving electrolyte burning, smoke from vehicles, or inhalation of toxic gases or vapors, there are several serious health and safety risks. Here's a breakdown of what to watch for and how to respond:

Electrolyte Burning (e.g., Lithium-ion Batteries):

Electrolyte materials, especially from lithium-ion batteries, can burn intensely and release toxic and corrosive vapors, including:

- Hydrogen fluoride (HF)
- Phosphorus oxides
- Carbon monoxide and dioxide
- Volatile organic compounds (VOCs)

Risks:

- Severe eye, skin, and respiratory irritation or damage
- Risk of chemical burns and asphyxiation

Advice

- Avoid exposure; use self-contained breathing apparatus (SCBA) and chemical-resistant gear

6-1.2 Use a thermal imaging camera

As a precaution, it is strongly recommended for first responders to utilize a thermal imaging camera to verify that there is no potential for thermal runaway and reignition.

Once the battery has been completely cooled down (which may require up to 24 hours), it should be continuously monitored for an additional hour to ensure that there is no reoccurrence of heat. Subsequently, the vehicle should be driven to an open and level area, and a 15-meter safety zone should be established to prevent individuals from approaching the vehicle.



Responders should always protect themselves with Personal Protective Equipment (PPE), including a Self-Contained Breathing Apparatus (SCBA), and take appropriate measures to protect civilians downwind from the incident.

POTENTIAL RISK OF HV-BATTERY FIRE RE-IGNITION / DELAYED FIRE!



6-1.3 Gas strut - Risk of missile effect

Gas struts in the vehicle tailgate present a significant missile effect hazard during a vehicle fire. These struts are under high internal pressure from gas (typically nitrogen) and oil. In a fire, the intense heat can cause the gas to expand rapidly, leading to failure and propelling components at high speeds.



7. In case of submersion

7-1 Water Submersion

When pulling a vehicle out of water, it's important to first try to get it out as much as possible. Then, immobilize and disable the vehicle before beginning any operation.

For high voltage system disabling methods, refer to chapter 3 "Disable direct hazards / Safety regulations".

For rescue procedures, refer to chapter 4 "Access to the occupants".



Damage level of submerged vehicle may not be apparent. Handling a submerged vehicle without appropriate Personal Protective Equipment (PPE) will result in serious injury or death from electrical shock.



- **Always wear appropriate Personal Protective Equipment (PPE) and remove/ drain water before removing the service plug when working on a vehicle after a fire or submersion to avoid electrical shock.**
- **If the vehicle is in the water, to avoid electrical shock NEVER touch the high-voltage components, harnesses or service plug. PPE must always be worn when touching or working on high-voltage components.**



8. Towing / transportation / storage

8-1 Jump Starting Procedures

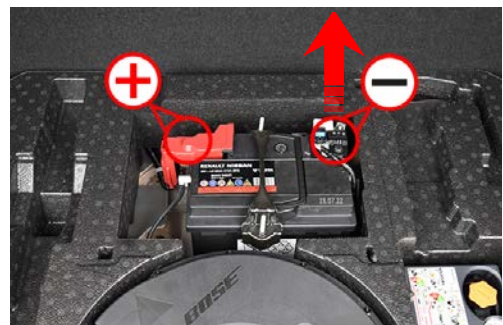
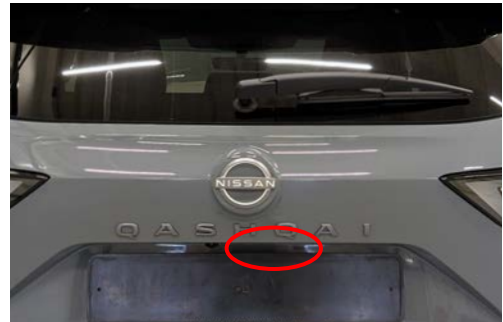
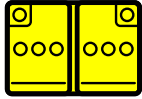

1. If the booster battery is in another vehicle, position the two vehicles to bring their 12-volt batteries into close proximity to each other. DO NOT allow the two vehicles to touch.

NOTE: Refer to the owner's manual for vehicle specific information.

2. Apply the parking brake.

If the 12-volt battery is discharged, the power switch cannot be moved from the OFF position. Connect the jumper cables to the booster vehicle before pushing the power switch.

3. Push the P (Park) position switch to place the vehicle in the P (Park) position.
4. Switch off all unnecessary electrical systems (headlights, heater, air conditioner, etc.).
5. Place the power switch in the OFF position.
6. Remove the vent caps (if so equipped) on the 12-volt battery.
7. Connect jumper cables in the right sequence.



- Always connect positive (+) to positive (+) and negative (-) to body ground, not to the 12-volt battery.
- Make sure the jumper cables do not touch moving parts in the motor compartment and that the cable clamps do not contact any other metal.

8. Start the engine of the booster vehicle.
9. **While the booster vehicle engine is running, turn the power switch ON while pressing the brake pedal in order to place the vehicle in READY mode.**

1

2

3

4

5

6

7

8

9

10

8-2 P (Park) Position Release Procedure

When power switch is turned OFF, the vehicle automatically shifts to P position. If you need to release the vehicle from the P (Park) position, proceed as follows.



To avoid possible personal injury or vehicle damage, use wheel chocks or take appropriate steps to prevent the vehicle from rolling freely. Never set the vehicle in READY state.

Be sure to firmly position wheel chocks before P (Park) position is released.

1. Twelve volt electric power is supplied with booster cable to the 12-volt battery.
2. Turn power switch ON by pushing the power switch 2 times without pressing brake pedal.
3. Check that parking brake is activated. (Check that indicator lamp for parking brake is ON.)
4. Place the selector lever in the N (Neutral) position: Close all doors, depress brake pedal and shift to "N" position. After maintaining this status some time, check that shift position indicator is indicated to "N" position.
5. Open hood and remove fuse and fusible link block cover. Remove 30A fuse.

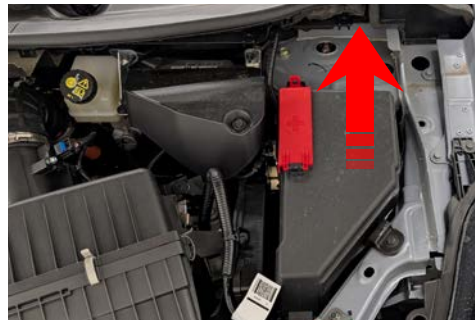

Or:

Remove fuse and fusible link block cover on the driver side of the dashboard. Remove 30A fuse.

NOTE:

When the door is open in the "N" position, the warning chime is sounded.



6. Release parking brake.

1

2

3

4

5

6

7

8

9

10



To avoid possible personal injury or vehicle damage, use wheel chocks or take appropriate steps to prevent the vehicle from rolling freely.



The parking lock for vehicles equipped electric shift switches (vehicles with a P position switch) cannot be released while the 12 V negative (-) battery terminal is disconnected. When moving the vehicle, use a jack, etc.

8-3 Towing Guidelines

Nissan strongly recommends towing with the driving (front) wheels off the ground or that the vehicle will be placed on a flatbed truck.

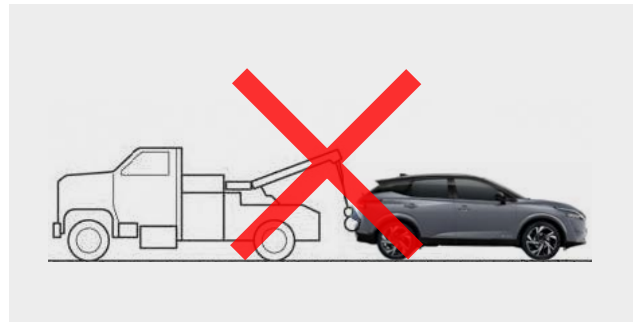
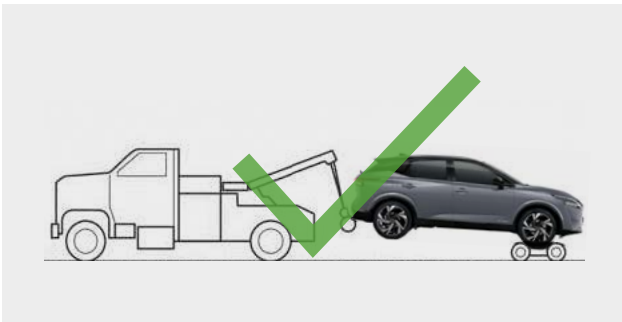
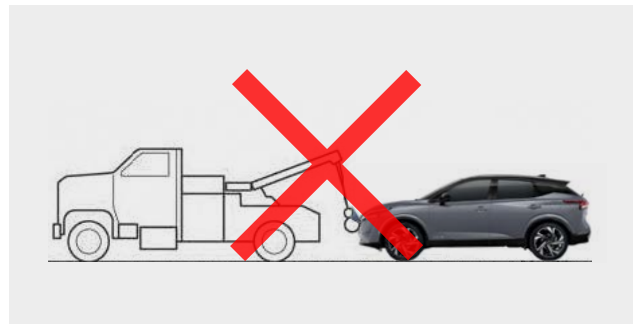
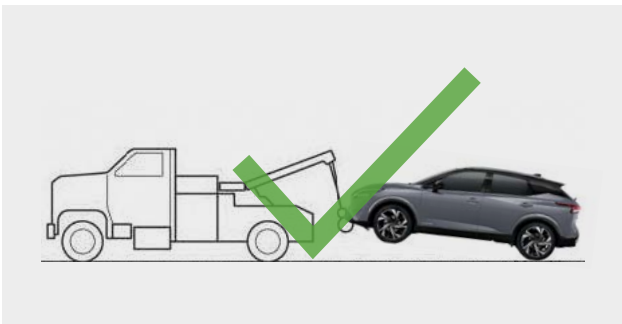
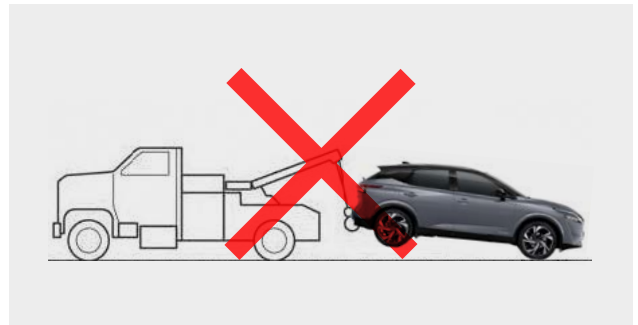
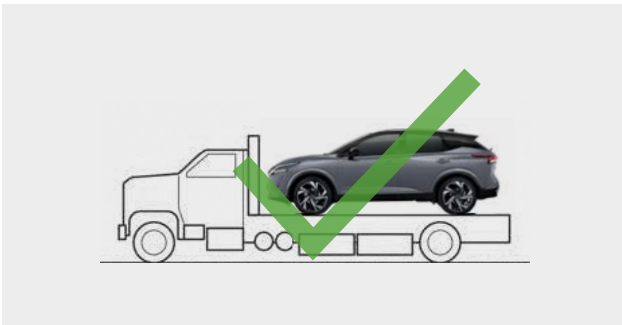

1

2

3

4

5

6

7

8

9

10

NOTE:

It is also permissible to transport the vehicle facing rearward on a flatbed.

NOTE:

If the vehicle cannot be placed in Neutral, a P (Park) release procedure may be required.

Use of Vehicle Equipped Hooks for Recovery Operations

If the vehicle is stuck in sand, snow, mud, etc., use a tow strap or other device designed specifically for vehicle recovery. Always follow the manufacturer's instructions for the recovery device.

**Front Tie Down Hook:**

- Do not use the front tie down hook for towing or vehicle recovery.

**Rear Tie Down Hook:**

- Do not use the rear tie down hook for towing or vehicle recovery.



To avoid vehicle damage, serious personal injury or death when recovering a stuck vehicle:

- Never tow with the front wheels on the ground or four (4) wheels on the ground (forward or backward), as this may cause serious and expensive damage to the motor.
- Transport the vehicle only after turning the power switch OFF.
- When towing the FWD vehicle with the rear wheels on the ground (if you do not use towing dollies), always release the parking brake.
- Safety chains or cables must be attached only to the main structural members of the vehicle. Otherwise, the vehicle body will be damaged.
- Only use devices specifically designed for vehicle recovery and follow the manufacturer's instructions.
- Do not use the vehicle tie down hook to tow or free a vehicle stuck in sand, snow, mud, etc.
- Always pull the cable straight out from the front of the vehicle. Never pull on the vehicle at an angle.
- Pulling devices should be routed so they do not touch any part of the suspension, steering, brake, high-voltage or cooling systems.
- Pulling devices such as ropes or canvas straps are not recommended for use in vehicle towing or recovery.
- Route recovery devices so they do not touch any part of the vehicle except the attachment point.

8-4 Storing the Vehicle

- If the vehicle needs to be stored or left unattended, the high-voltage system must be shut down and a sign put on the vehicle indicating it is an electric vehicle with high-voltage dangers.



- **The service plug must be removed (Refer to 3-3.2 Alternate Procedure 1 - Remove Service Plug) to shut down the high-voltage system for storage.**
- **Do not store a vehicle inside a structure. Keep the vehicle away from other vehicles if the high-voltage battery is severely damaged. There is possibility of delayed fire from a severely damaged high-voltage battery.**

- Drain gasoline, oil and other fluids, then disconnect the negative (-) terminal of the 12 V battery before storing a damaged vehicle.
- Submerged Vehicle: In addition to the normal procedures, remove the water from the vehicle.



How to handle a vehicle post fire:

- **Just like conventional vehicles, for fire safety reasons electric/hybrid vehicles that have been involved in accidents should be parked in a restricted-access section of an open-air parking area a sufficient distance away from other vehicles, buildings, flammable objects and flammable surfaces.**
- **It is never recommended to park an electric/hybrid vehicle with a damaged high-voltage system in an enclosed hall.**
- **Alternatively, electric/hybrid vehicles involved in accidents may be parked in dedicated fire protection systems.**
- **Parked electric/hybrid vehicles involved in accidents, which have high-voltage components directly exposed to the weather, should be covered with a weatherproof tarpaulin.**
- **The vehicle should be marked accordingly, especially if it is to be delivered outside business hours.**



- **A vehicle that has been submerged in water poses a threat of vehicle fire after some time for possible short circuits due to electrical corrosion (wiring and circuit boards to corrode in an electrochemical reaction with water). To store a vehicle that has been submerged in water, choose a well-ventilated place at least 15 meters (49.2 feet) away from other objects.**
- **To prevent a vehicle fire, avoid turning the ignition switch or power switch of a submerged vehicle to ACC or ON.**

8-4.1 Danger Sign Example

If the vehicle needs to be stored or left unattended, the high-voltage system must be shut down by removing the service plug, and a sign put on the vehicle indicating it is an electric vehicle with high-voltage dangers. For example:



_____ : Person in charge

DO NOT TOUCH!

HIGH VOLTAGE BATTERY

DAMAGED VEHICLE WITH

DANGER:

DANGER:

DAMAGED VEHICLE WITH

HIGH VOLTAGE BATTERY

DO NOT TOUCH!

Person in charge : _____



Copy this page and put in after folding on the roof of the vehicle in service

8-5 Preparation for Dismantling



- Failure to properly shut down the high-voltage electrical system before the Dismantling Procedures are performed will result in serious injury or death from electrical shock. To prevent serious injury or death, **NEVER** touch high-voltage harnesses or components without always wearing appropriate Personal Protective Equipment (PPE).
- If it is necessary to touch any of the high-voltage harnesses or components you must always wear appropriate PPE to avoid electrical shock. Shut down the high-voltage system by following the steps outlined in 3-3 Powering Down the High-voltage System. Wait at least ten (10) minutes for complete discharge of the high-voltage capacitor after the high-voltage system has been shut down.



- **NEVER** assume the vehicle is shut OFF simply because it is quiet.
- If it becomes necessary for the dismantler to leave the vehicle, place a "DANGER" sign (for example, refer to 8-4.1 Danger Sign Example on the vehicle to alert other people that the vehicle contains a high-voltage battery).

NOTE:

We strongly advise to bring the vehicle to a Nissan Service Centre for battery dismantling and discharging.

9. Important additional information

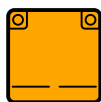

9-1 Recovery/Recycling of the High-voltage Battery

The high-voltage battery is fully recyclable. For information regarding safe recovery and recycling of the high-voltage battery, it is recommended you contact the nearest NISSAN certified dealer. For assistance in finding your nearest dealer please call Nissan Customer Assistance at:

| Country | Local Phone Number | International Phone Number |
|----------------|--------------------|----------------------------|
| Austria | 0800 21 53 80 | +43 190 57 77 77 |
| Belgium | 00 800 5000 1001 | +32 3 870 34 49 |
| Bulgaria | 0700 16 616 | * |
| Croatia | 0800 00 20 | * |
| Cyprus | 99216003 | * |
| Czech Republic | 800 23 23 23 | +420 2 3429 0880 |
| Denmark | +45 70 14 01 47 | * |
| Estonia | 606 4070 | +372 606 4070 |
| Finland | 010 770 5222 | +358 10 770 5222 |
| France | 0805 11 22 33 | +33(0) 1 72 67 69 14 |
| French Guiana | 594 694 42 17 61 | * |
| Germany | 0800 / 58 949 87 | +49 2232 / 57 20 79 |
| Greece | 2103479700 | * |
| Guadeloupe | 0590 590 41 42 43 | +590 590 25 25 35 |
| Hungary | 06-80-333-888 | +36 1 371 54 93 |
| Ireland | 1 800 264 264 | +353 14091100 |
| Italy | 800 105 800 | +39 06 908 087 77 |
| La Reunion | 02 62 98 00 00 | * |
| Latvia | 8000 3211 | +372 606 4071 |
| Lithuania | 8800 30725 | +372 606 4072 |
| Luxembourg | 00 800 5000 1001 | +352 (0)3 870 34 01 |
| Macedonia | 0800 00 20 | * |
| Malta | (+356) 2596 9999 | +356 2596 9999 |
| Martinique | 0596 57 24 24 | +596 596 57 24 24 |
| Montenegro | 020 892-070 | * |
| Netherlands | 0800 0231513 | +31 205162026 |
| Norway | 815 21 310 | +47 66 98 39 27 |
| Poland | 0 801 647726 | +48 22 631 07 48 |
| Portugal | 800 200 000 | +351 800 200 000 |
| Romania | 248 500 550 | * |
| Serbia | 0800 10 80 10 | * |
| Slovakia | 0800 11 20 20 | +421 2 330 70 440 |
| Slovenia | 080 21 81 | * |
| Spain | 900 118 119 | +34 932 907 515 |
| Sweden | 085 010 3000 | +46 8 5010 3000 |
| Switzerland | 0800 86 09 00 | +41 800 86 0900 |
| Ukraine | 0800 303 307 | * |
| United Kingdom | 0330 123 1231 | +44 191 335 2879 |

9. Important additional information

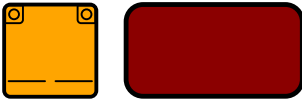

9-2 The Technology of e-Power

The e-POWER system is comprised of a high-voltage battery and the powertrain, which is integrated with a high-power motor, inverter, gasoline engine, and a generator. In conventional hybrid systems, the wheels are driven by an electric motor and a gasoline engine. However, in the e-POWER system, the wheels are driven by a high-output electric motor like an EV.

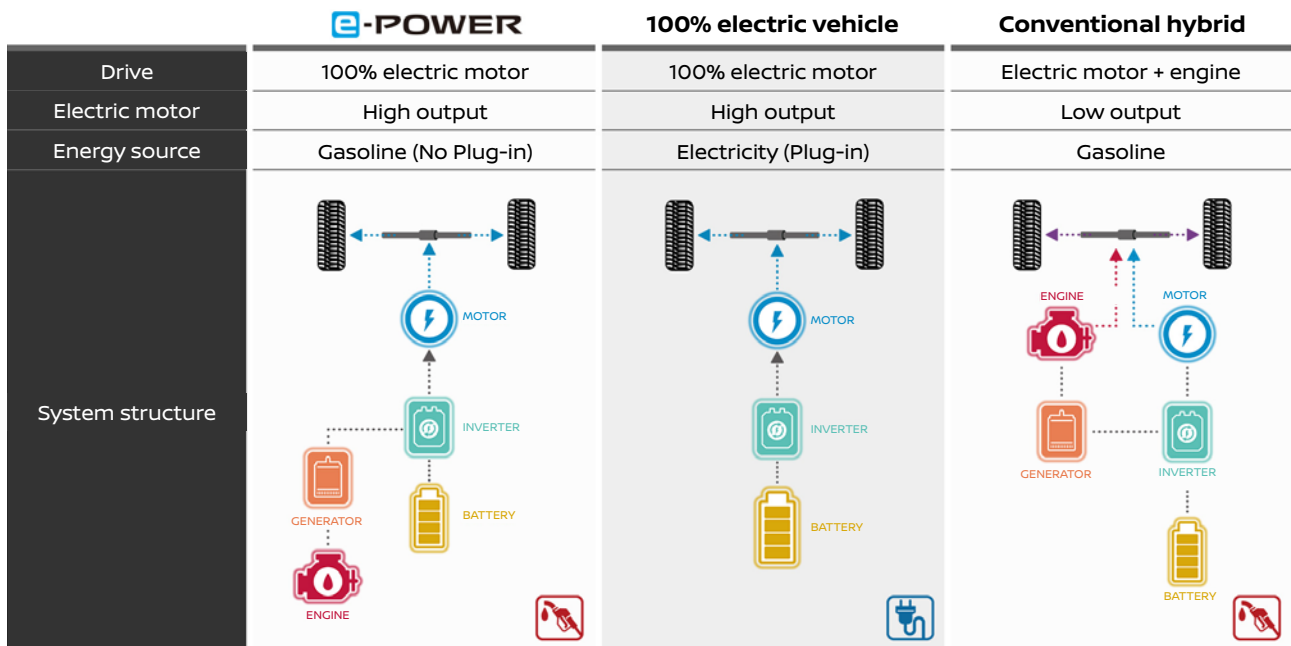

1

2

3

4

5

6

7

8

9

10

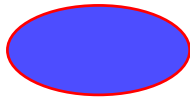

9-3 Passive Safety System Component Parts Location

In the event of a strong impact that could cause serious injury, the vehicle's airbags deploy and seatbelts restrain the occupants to minimize the impact on their bodies.

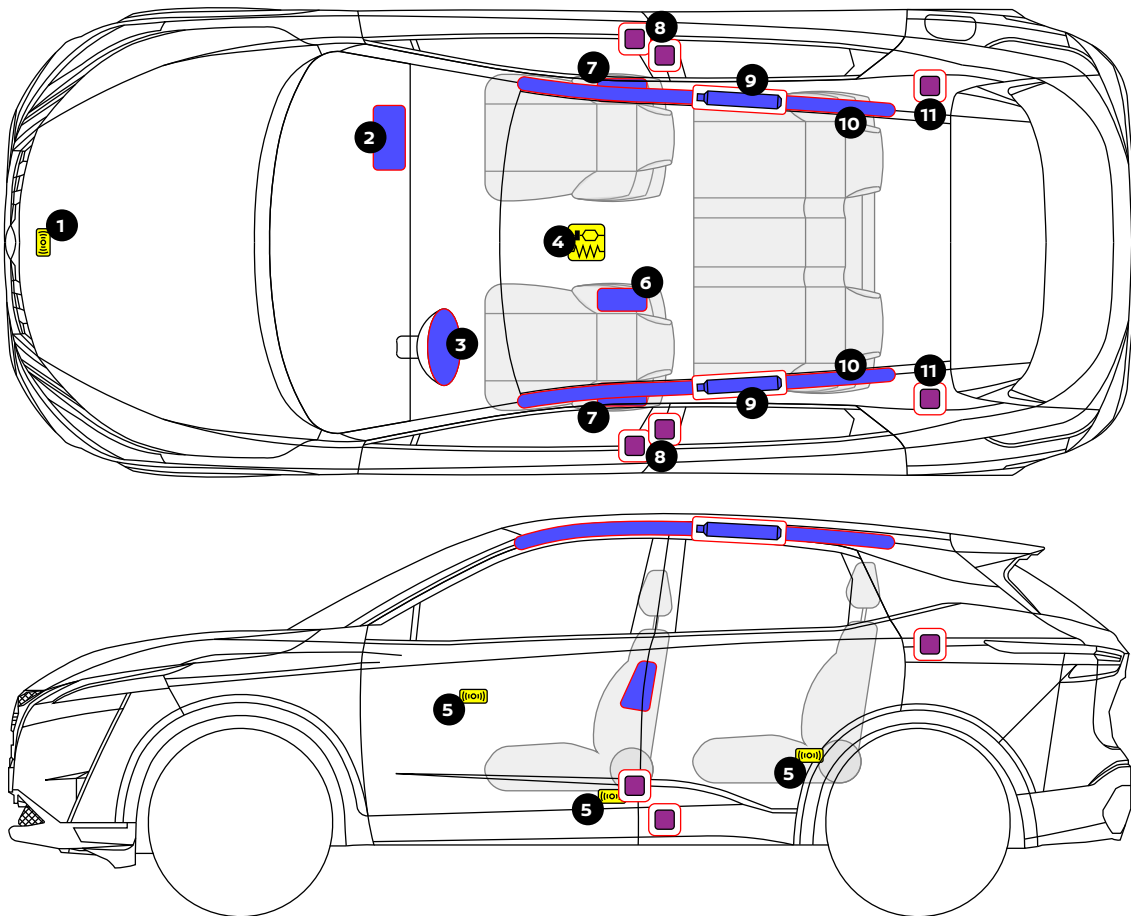

1 Front Impact sensor

2 Front passenger airbag

3 Driver's airbag

4 SRS control unit

5 Side Impact Sensors

6 Front center airbag

7 Side airbags

8 Seat belt pretensioner

9 Stored gas inflator

10 Side curtain airbags

11 Rear Seat belt pretensioners



- The SRS airbag may remain powered for up to 3 minutes after the vehicle is shut off and disabled. Wait at least 3 minutes before starting any operation. Failure to shut off and disable the vehicle before emergency response procedures are performed may result in serious injury or death from unintentional deployment of the SRS airbag.
- Depending on the circumstances surrounding a collision, such as vehicle speed, point of impact, occupant detection etc., SRS airbags will not always be deployed. If an inflator of the undeployed SRS airbag is breached, the powder inside the inflator may ignite resulting in unintentional SRS airbag deployment. To prevent serious injury or death from unintentional SRS airbag deployment, avoid breaching the inflators.
- Immediately after an SRS airbag is deployed, the components are extremely hot and may cause burns if touched.
- If an SRS airbag deploys with all doors and windows closed, inflation gas may cause breathing difficulty.
- If residue that is produced during SRS airbag deployment comes in contact with skin, rinse it off immediately to prevent skin irritation.



- The seatbelt pretensioners may remain powered for up to 90 seconds after the vehicle is shut off and disabled. Wait at least 90 seconds before starting any operation. Failure to shut off and disable the vehicle before emergency response procedures are performed may result in serious injury or death from unintentional actuation of the seatbelt pretensioner.
- To prevent serious injury or death from unintentional seatbelt pretensioners actuation, avoid breaching the seatbelt pretensioners.























- If a gas-filled damper is heated in an event of a vehicle fire, the damper may explode due to expanded nitrogen (N₂) gas, possibly causing an injury.
- If a gas-filled damper is cut, nitrogen (N₂) gas may cause metal shavings from the cut to scatter. Wear appropriate safety gear such as safety glasses when cutting a gas-filled damper.

10. Explanation of pictograms used

10-1 Explanation of pictograms used

This manual describes emergency response operations and important safety related warnings for Nissan vehicles. You may see various symbols in this manual. They have the following meanings:

| | | | |
|-------------------------------------------------------------------------------------|---------------------------------------|-------------------------------------------------------------------------------------|---------------------------------------------------|
|  | Warning, Electricity |  | Hybrid Electric Vehicle on fuel of liquid group 2 |
|  | General warning sign |  | Flammable |
|  | Warning; low temperature |  | Hazardous to the human health |
|  | Air-conditioning component |  | Acute toxicity |
|  | Use ABC powder to extinguish the fire |  | Explosive |
|  | Use water to extinguish the fire |  | Corrosives |
|  | Remove smart key |  | Steering wheel, tilt control |
|  | Bonnet |  | Seat height adjustment |
|  | Boot |  | Seat adjustment, longitudinal |
|  | Use thermal infrared camera |  | Crash sensors |
|  | Lifting point; central support | | |

